













Unpacking

Before you begin using the device, please check the version you obtained and ensure that the following items are included in the shipped box:

Universal Accessories:

	E12 x 1		Plastic wall anchor x 4		M3x4 screw x 4
	Wall mounting bracket x 1		Back cover x 1		Torx wrench x 1
	ST4x20 screw x 4		7-pin cable x 1		6-pin cable x 1
	Torx screw x 2		Wall-mounting template x 1		Diode x 1

Product Overview

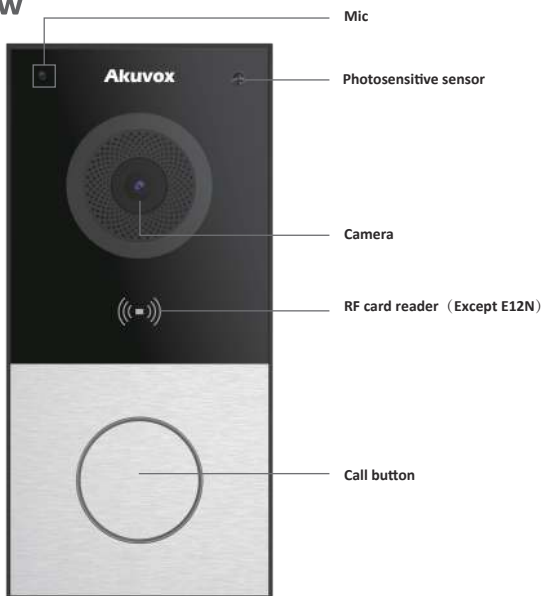

E12

Installation Environment

Indoor and outdoor installation are supported.

If installing the device outdoors, please don't place device under direct sunlight, it will bring a bad effect or be broken with the high temperature.

If installing the device indoors, please keep device at least 2 meters away from light, and at least 3 meters away from window and door.

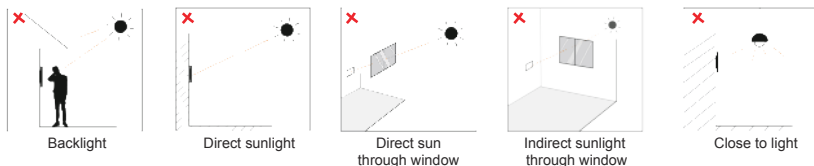

Installation

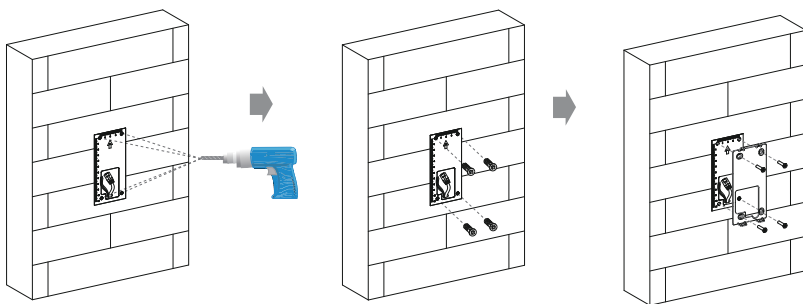

According to the position of the reserved wires on the wall, stick the wall-mounting template vertically to ensure that the wires can come out of the shadow position of template. Drill (6 mm drill bit required) four screw holes with a depth of 25mm in the screw holes of the template.

Insert four plastic wall anchors into the holes.

Fix the wall-mounting bracket on the wall by tightening four ST4x20 screws to the plastic wall anchors.

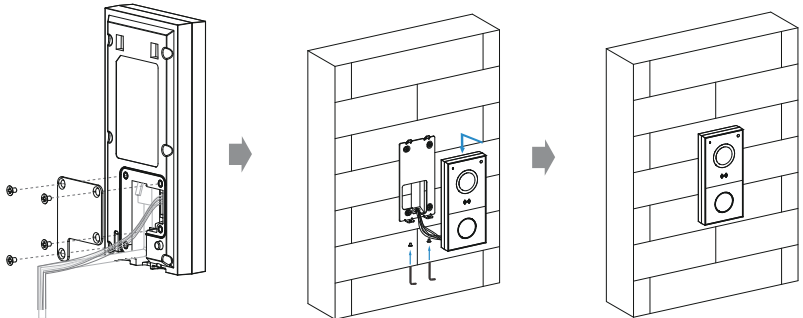

Connect the wires to the interface of the device as needed (for details, refer to "Device Wiring"). After arranging the wires, tighten the back cover using four M3x4 screws to the device.

Hang the device on to the two square hangers on the wall-mounting bracket, then use the Torx Wrench attached to tighten the bottom of the device with two Torx screws.

The installation is completed.

Application Network Topology

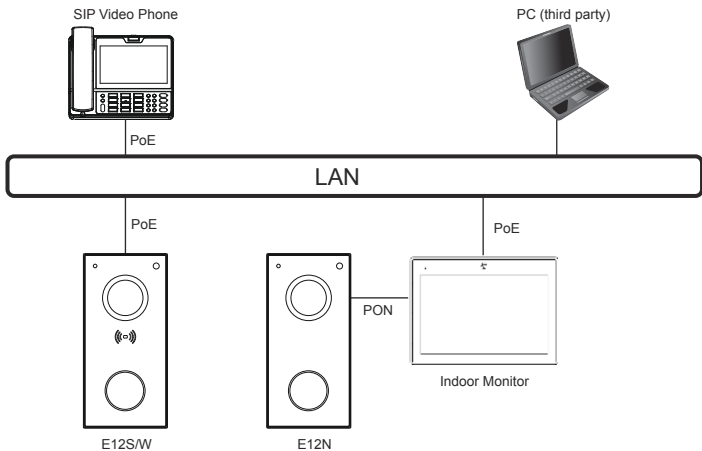

Device Wiring

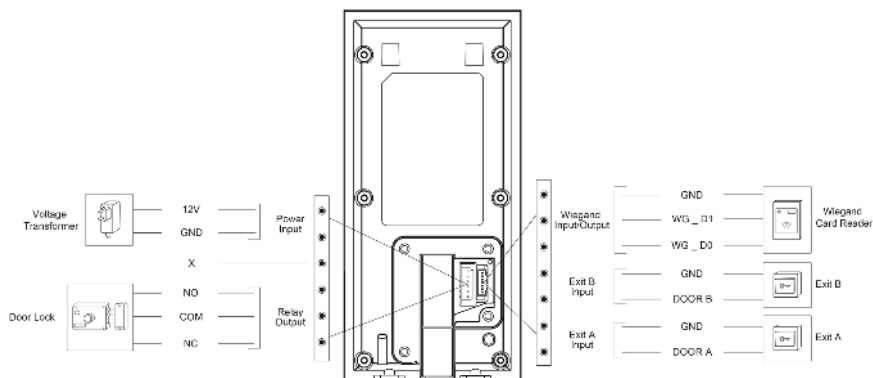

⚠ Warning

When you connect a device containing a coil, such as a relay or an electromagnetic lock, it is necessary to protect the intercom against voltage peak while switching off the induction load. For this way of protection we recommend a diode 1 A / 200 V (included in the accessories) connected antiparallel to the device.

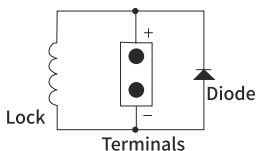

IP Announcement

1. While E12 starts up normally, hold the call button for several seconds after the LED light turns blue, voice system will enter IP announcement mode.
2. In announcement mode, the IP address will be announced periodically.
3. Press Call Button again to the announcement mode.
4. In announcement mode, phone announces "IP 0.0.0.0" if no IP address is gained.

Operation

Make a call:

1. Press the call button to call indoor SIP Phone.
2. During the talk, called party can press pre-configured code number to unlock the door.

Receive a call:

E12 supports Auto Answer by default. Incoming call from indoor device will be answered automatically.

Configuration

1. Access the Web UI: Input the IP address into web browser to configure the phone.
2. Account Registration: On web UI, go to the path: **Account -> Basic** page
Register Account and fill in the account information. (*Please refer to user manual for more information*)
3. Configure the Push Button: On web UI, go to the path: **Intercom -> Basic -> Push Button** to configure the call number.
4. Configure the code to open the relay: On web UI, go to the path: **Intercom -> Relay&Input -> Relay ID/DTMF** and choose the DTMF code number in corresponding area.

Indicators

Name	Status	Description
Status Indicator	Blue Light Always On	Normal status
	Blue Breathing Light	Calling
		Receiving a call
	Blue Light Always On > Red Light Always On > Purple Light Always On	Restarting
	Red Breathing Light	Network is unavailable / Obtaining network
	Purple Light Always On	Talking
	Red/Purple Light Flashing	Firmware upgrading

Note: For more LED settings, please refer to E12 webUI: **Intercom -> LED Setting.**

Notice Information

Information contained in this document is believed to be accurate and reliable at the time of printing. This document is subject to change without notice, any update to this document can be viewed on Akuvox' s website: <http://www.akuvov.com> © Copyright 2021 Akuvox Ltd. All rights reserved.



AKUVOX (XIAMEN) NETWORKS CO., LTD.

ADD: 10/F, NO.56 GUANRI ROAD, SOFTWARE PARK II, XIAMEN 361009, CHINA
www.akuvov.com